

5215 / 5216

Thermotouch 9.2mG

Manual thermostat for electric underfloor heating

Installation & User Guide

thermotouch
UNDERFLOOR HEATING CONTROLS

Contents

Compatibility	3
What's in the box?	4
Before you start	5
Installing your thermostat	6
Wiring diagram	11
Switching on your system	13
Settings	14
User interface	16
Technical data	17
Key lock	18

Compatibility

Thermostouch 9.2mG is compatible with Thermogroup NTC 10K floor sensor probes.

NTC 10k Ω @ 25°C

If your existing floor probe is from another thermostat manufacturer and is not compatible, set your thermostat to ambient temperature sensing mode.

(Not advisable for timber or other temperature sensitive floors).

Replacing an existing thermostat?

Contact the manufacturer's technical department and ask for the rating of the floor sensor at 25°C.

What's in the box?

Check you've got everything:

- Manual thermostat (5215 or 5216)
- Floor sensor probe (3m)
- Floor sensor conduit (2m)
- Fixing screws
- Installation guide

You will also need:

- Electrical screwdriver
- Deep electrical back box
- Electrical test meter

Before you start

Your thermostat should be:

- Installed 1.2 - 1.5m from the floor
- On an interior wall
- Outside any wet zones (IP30)
- Installed on an RCD protected circuit
- Away from drafts or heat influences
- Installed so that the floor sensor probe can be laid in a heated area of the floor
- Installed by a professional, in line with current IEE 17th Edition Part P regulations and local standards

Installing your thermostat

1. Switch off mains power

You will be installing your thermostat as part of a high voltage mains electrical circuit. To ensure your safety and to protect the thermostat, switch off the mains power and remove fuse from the spur before you start the installation.

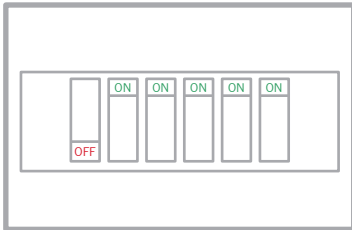
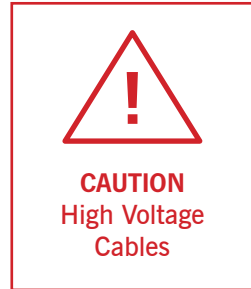

Fuse Box

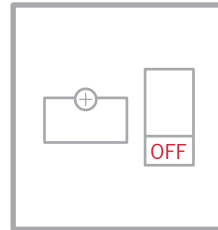

Fused Switch

Installing your thermostat

2. Installation location

At this stage it is likely that an RCD protected electric underfloor heating system has been installed and a back box is already in place.

The underfloor heating cold tail should be pulled up through the back box, and the sensor probe installed (in the conduit provided) within the wall cavity or pre-chased channel in a solid wall.

Installing your thermostat

3. Maximum distances

Your thermostat can be installed up to 50m away from the underfloor heating system it is controlling, provided that the floor sensor is used to control the temperature.

Underfloor heating cold tails and floor sensor probes can be extended up to 50m.

Connect multiple heaters in parallel.

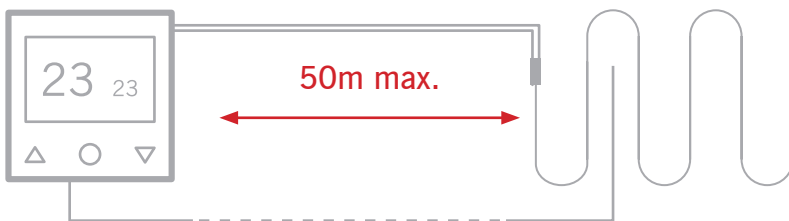

Installing your thermostat

4. Release mounting plate

Use a flat screwdriver to press in the catch and push the fascia down as shown to release the clips holding the back plate and the thermostat fascia together. Disconnect the white ribbon cable.

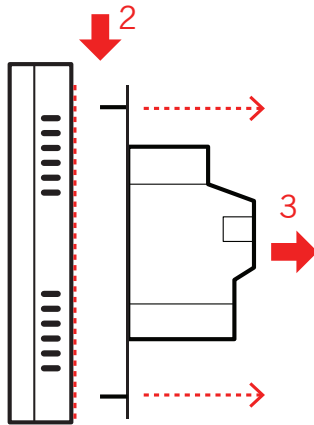
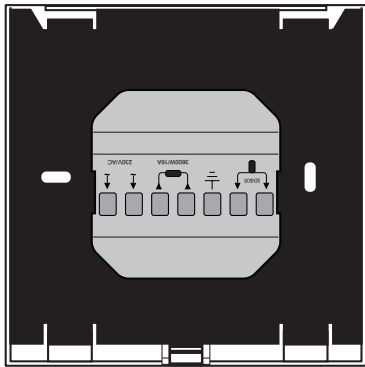

Do not try to force the back plate off without first pushing the fascia down to release the clips!

Installing your thermostat

5. Wiring diagram

Connect the Thermostat to the underfloor heating (UFH) cold tail, power supply and floor temperature sensor.

The floor temperature sensor is not polarity sensitive.

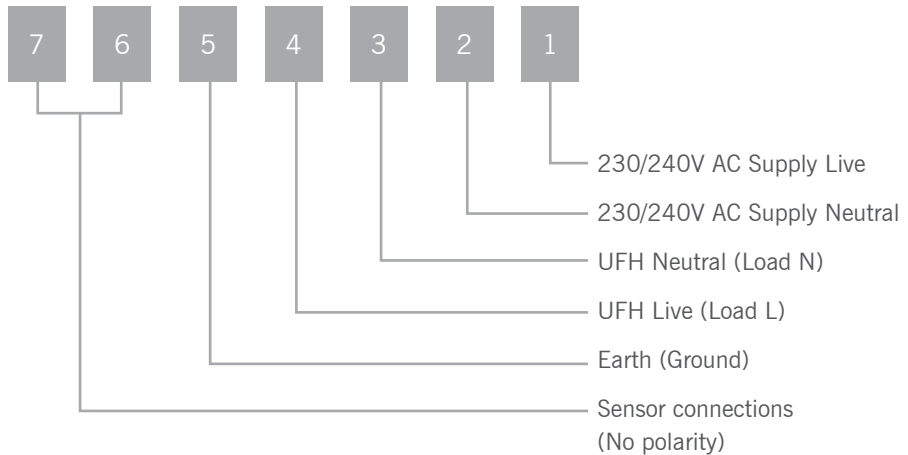

Installing your thermostat

6. Fix mounting plate in position

Use a cross-head screwdriver to fix the mounting plate to the back box in the wall. Now you can connect the white ribbon cable to the fascia.

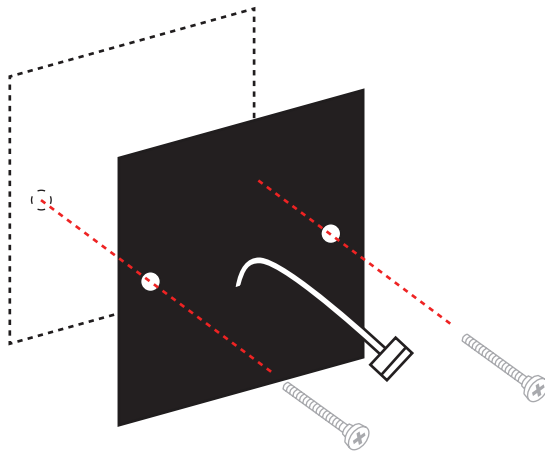

Installing your thermostat

7. Fix thermostat fascia in place

Locate the thermostat onto the mounting plate and push down to clip in place.

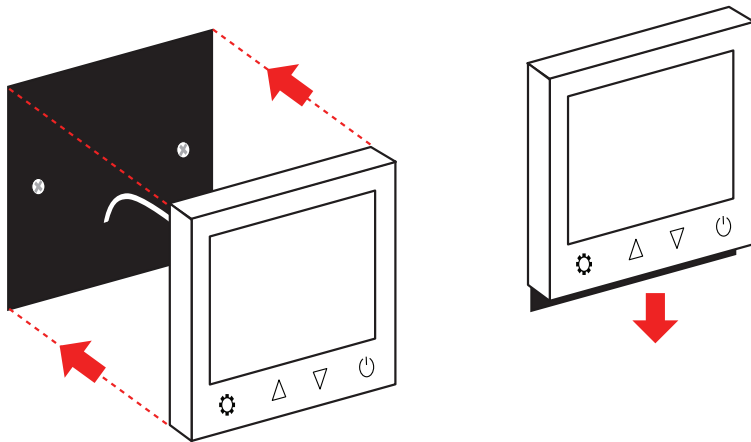

Installing your thermostat

8. Switching on your system

It is important that all adhesives and grouting is dry and fully cured before you switch on your underfloor heating.

Most adhesives take between 7 to 10 days to cure. Follow manufacturer guidelines.

The temperature of your underfloor heating should be increased gradually to avoid thermal shock in the floor. Start at 15°C and work up to your desired temperature 2-3°C per day.

Observe any maximum temperature guidelines from your floor manufacturer.



**Wait for
7 - 10 Days
before you
switch on**



Advanced Settings

Adjusting the settings

To access the settings, switch the unit off by pressing .

Press and hold  and  together for 7 seconds.

Press  to cycle between settings 01 to 12.

Use  and  to adjust the settings.

When you are finished, leave the thermostat idle for 30 seconds. It will automatically save your settings and switch off.

Switch the unit on by pressing  to continue using the thermostat with your new settings.

Advanced Settings

MENU	DESCRIPTION	RANGE	DEFAULT
01	Temperature calibration	-8°C ~ 8°C	0°C
02	Maximum set point	5°C ~ 80°C	35°C
03	Minimum set point	5°C ~ 80°C	5°C
04	Sensor mode	IN (Ambient), OUT (Floor), ALL (Ambient with floor limit)	OUT
05	Frost protection	5°C ~ 15°C or - (Off)	5°C
06	Floor temperature display	(ALL sensor mode only)	
07	Temperature limit	10°C ~ 80°C (ALL mode only)	35°C
08	Status after power failure	LA: On as before, OF: Off after power failure	LA
09	Software version	5215: 7021 V1.1 5216: 5101 V1.1	
10	Factory reset	rE (yes)	
11	Backlight timer	10 secs - 300 secs (5 mins)	20s
12	Backlight brightness level	1 (min), 2, 3, 4 (max)	4

User interface

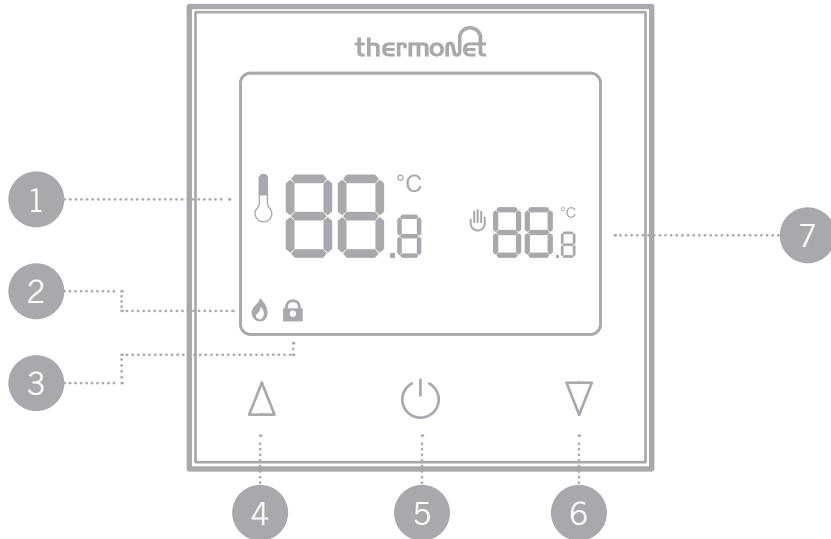



1. Measured temperature
2. Heating on icon
3. Lock icon
4. Up arrow
5. Power button
6. Down arrow
7. Set temperature

Technical data



Supply voltage	230V 50/60Hz
Maximum load	16A
Backup storage	EEPROM
Temperature range	5 ~ 80°C (0.5°C increments)
Accuracy	±0.5°C
Sensor rating	NTC 10kΩ @ 25°C
Consumption	2W
Warranty	3 years
IP rating	IP30
Width	85mm
Height	85mm
Depth	46mm (31mm in wall)

Key lock

Locking the keys



To lock the keys press and hold  and  together for 7 seconds.

The  icon will appear when the keys are locked and the keys will not function.

To unlock the keys press and hold  and  together for 7 seconds.

Factory reset

Find menu item 10 in the advanced settings (page 15).

Press  and then . The thermostat will reset to factory settings after 7 seconds. This will totally erase the time, date, heating program and any adjusted settings.

Notes

A series of 20 horizontal dotted lines for taking notes.

Service and support

Thermogroup UK

Bridge House
Hop Pocket Lane
Paddock Wood
Kent TN12 6DQ
UNITED KINGDOM

0800 019 5899
01622 689 440

www.thermogroupuk.com
sales@thermogroupuk.com

Thermogroup EU

Pinnacle House
Newtown Cross
The Ward, Dublin 11
D11 K27C
Rep. of IRELAND

01 866 0584

www.thermogroupeu.com
sales@thermogroupeu.com

Thermogroup AU

Thermogroup Pty Ltd
PO Box 822
Leeton NSW 2705
AUSTRALIA

1300 368 631

www.thermogroup.com.au
sales@thermogroup.com.au



Watch the video guide on our website

www.thermogroupuk.com

www.thermogroup.com.au

Thermogroup



That little bit extra...